

Surface Mount Superfast Recovery Rectifier

Reverse Voltage – 50 to 600 V

Forward Current – 1 A

FEATURES

- For surface mounted applications
- Low profile package
- Glass Passivated Chip Junction
- Superfast reverse recovery time
- Lead free in comply with EU RoHS 2011/65/EU directives

MECHANICAL DATA

- Case: SMA
- Terminals: Solderable per MIL-STD-750, Method 2026
- Approx. Weight: 0.055g / 0.002oz

PINNING

| PIN | DESCRIPTION |
|-----|-------------|
| 1 | Cathode |
| 2 | Anode |

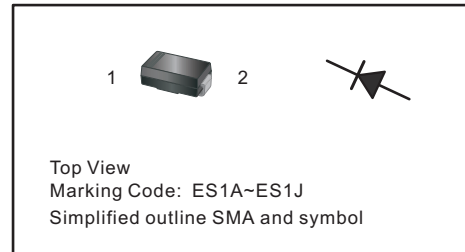

Absolute Maximum Ratings and Characteristics

Ratings at 25 °C ambient temperature unless otherwise specified. Single phase, half wave, 60 Hz, resistive or inductive load. For capacitive load, derate current by 20%.

| Parameter | Symbols | ES1A | ES1B | ES1C | ES1D | ES1E | ES1G | ES1J | Units |
|--|-----------------|------------|------|------|------|------|------|------|--------------------|
| Maximum Repetitive Peak Reverse Voltage | V_{RRM} | 50 | 100 | 150 | 200 | 300 | 400 | 600 | V |
| Maximum RMS voltage | V_{RMS} | 35 | 70 | 105 | 140 | 210 | 280 | 420 | V |
| Maximum DC Blocking Voltage | V_{DC} | 50 | 100 | 150 | 200 | 300 | 400 | 600 | V |
| Maximum Average Forward Rectified Current | $I_{F(AV)}$ | 1 | | | | | | | A |
| Peak Forward Surge Current 8.3 ms Single Half Sine Wave Superimposed on Rated Load (JEDEC Method) | I_{FSM} | 30 | | | | | | | A |
| Maximum Forward Voltage at 1 A | V_F | 1 | | | | 1.25 | | 1.70 | V |
| Maximum DC Reverse Current at Rated DC Blocking Voltage $T_a = 25\text{ }^\circ\text{C}$ $T_a = 125\text{ }^\circ\text{C}$ | I_R | 5 100 | | | | | | | μA |
| Typical Junction Capacitance at $V_R=4\text{V}$, $f=1\text{MHz}$ | C_j | 15 | | | | | | | pF |
| Maximum Reverse Recovery Time ⁽¹⁾ | t_{rr} | 35 | | | | | | | ns |
| Typical Thermal Resistance ⁽²⁾ | $R_{\theta JA}$ | 75 | | | | | | | $^\circ\text{C/W}$ |
| Operating and Storage Temperature Range | T_j, T_{stg} | -55 ~ +150 | | | | | | | $^\circ\text{C}$ |

(1) Measured with $I_F = 0.5\text{ A}$, $I_R = 1\text{ A}$, $I_{rr} = 0.25\text{ A}$.

(2) P.C.B. mounted with 1.0 X 1.0" (2.54 X 2.54 cm) copper pad areas.

Fig.1 Reverse Recovery Time Characteristic And Test Circuit Diagram

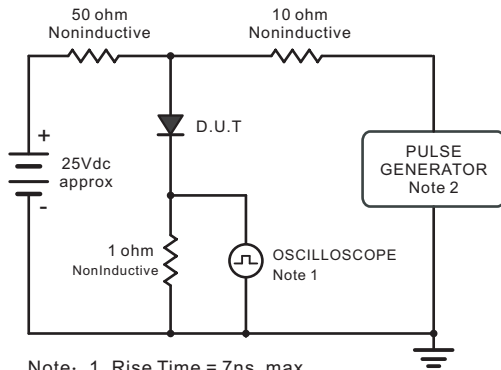

Note: 1. Rise Time = 7ns, max.
Input Impedance = 1megohm, 22pF.
2. Rise Time = 10ns, max.
Source Impedance = 50 ohms.

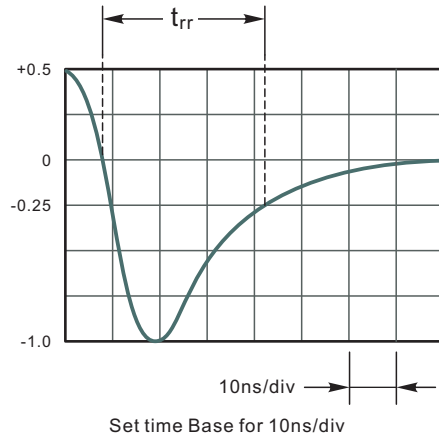

Fig.2 Maximum Average Forward Current Rating

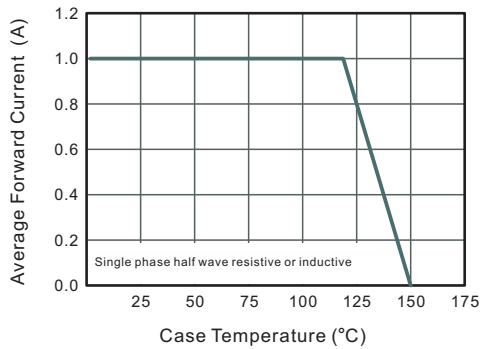

Fig.3 Typical Reverse Characteristics

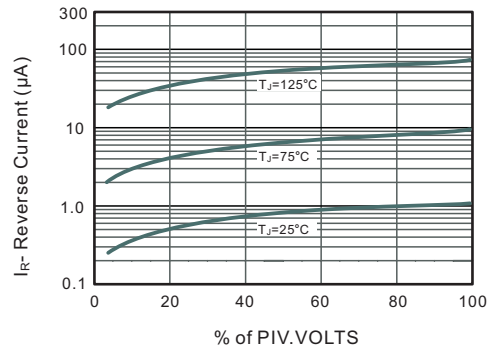

Fig.4 Typical Forward Characteristics

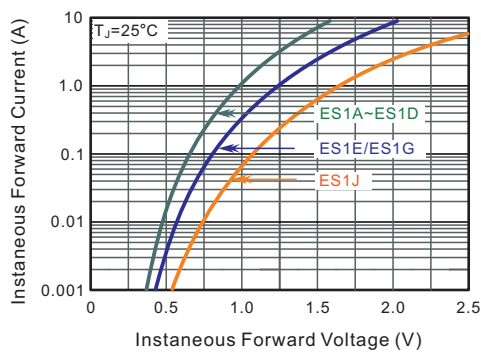

Fig.5 Typical Junction Capacitance

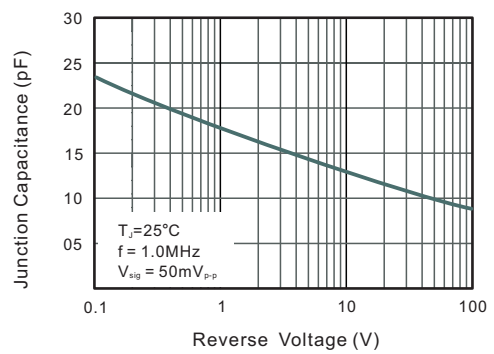
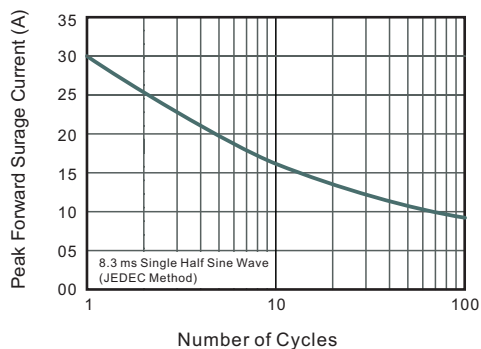
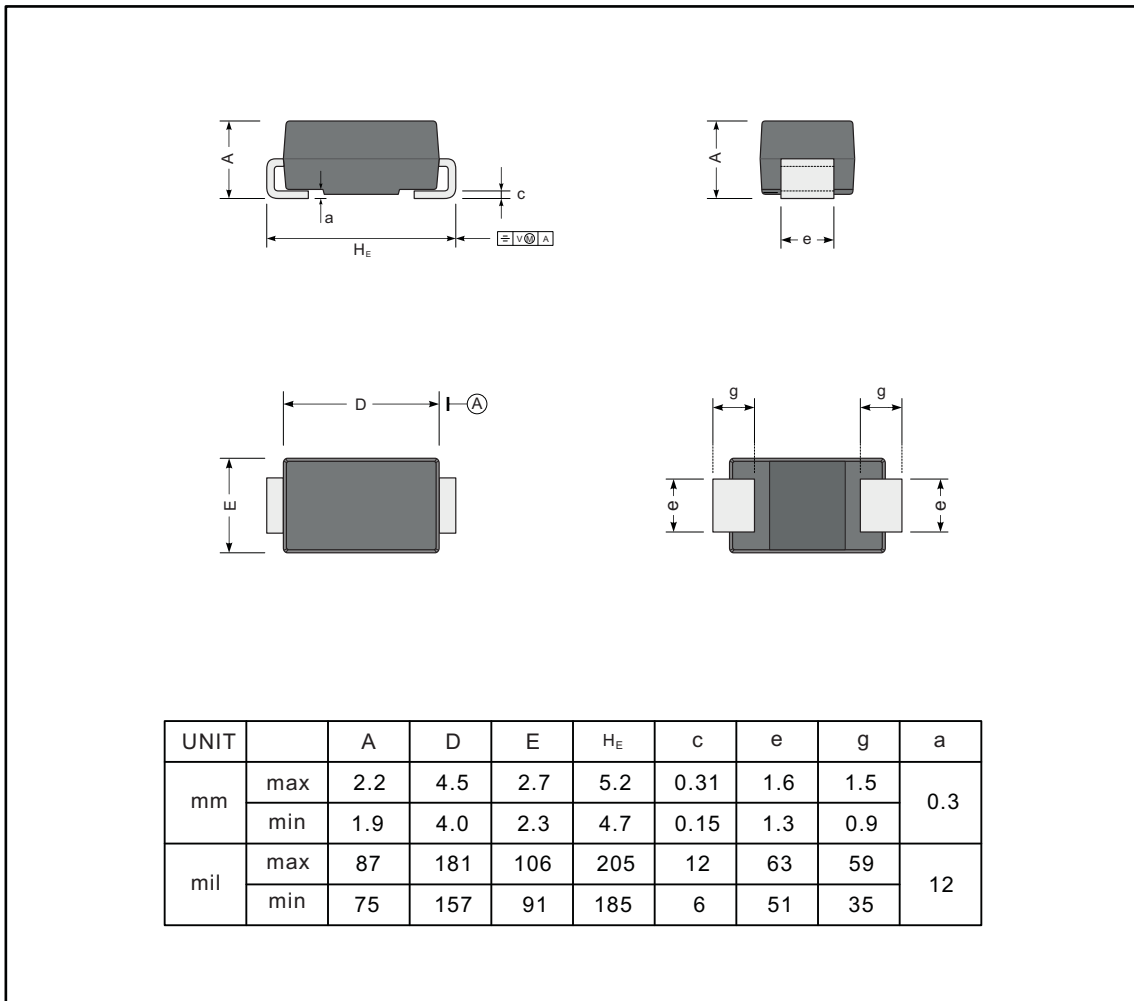
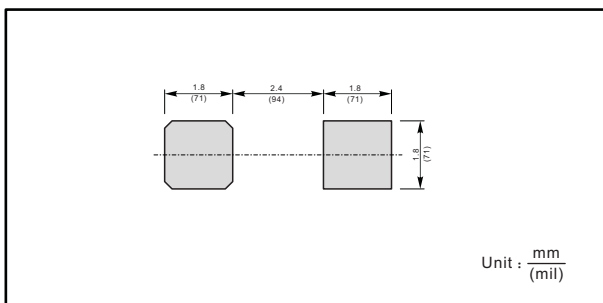

Fig.6 Maximum Non-Repetitive Peak Forward Surge Current



PACKAGE OUTLINE

Plastic surface mounted package; 2 leads

SMA

The recommended mounting pad size

Marking

| Type number | Marking code |
|-------------|--------------|
| ES1A | ES1A |
| ES1B | ES1B |
| ES1C | ES1C |
| ES1D | ES1D |
| ES1E | ES1E |
| ES1G | ES1G |
| ES1J | ES1J |